

Storage units **Lampo Open**

Modularity

MODULARITY WITH MODULAR TOP PANEL

heights

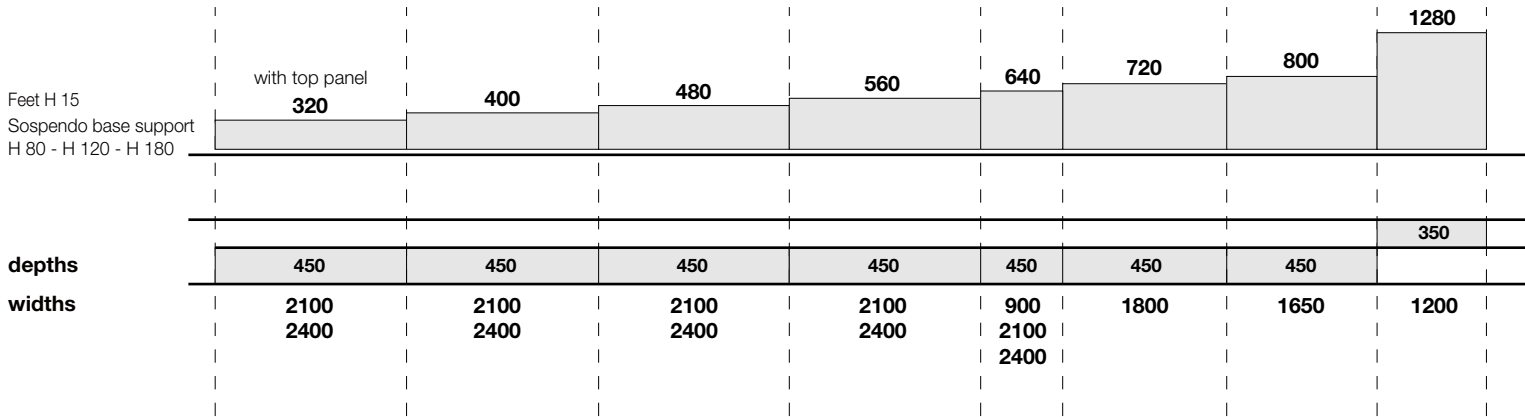

MODULARITY WITH 4-SIDED FRAME

heights

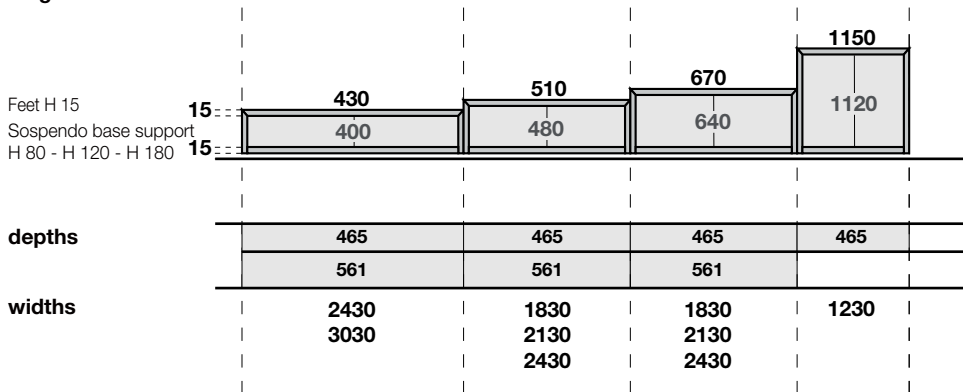

Open sideboards are made up of standard Lampo units with 20mm thick fronts and open units with 15mm thick structure and 45° joints. Sideboards with tops and frames are higher (15 and 30mm respectively) than sideboards with finished modular covers. The types of opening available are shown with a code next to the fronts.

Storage units **Lampo Open**

Structural features

OPEN SIDEBOARDS WITH UPPER OPEN UNITS WITH EXPOSED TOP PANEL

Sideboards with exposed upper Open units CANNOT BE FINISHED WITH FULL SUPERIMPOSED TOPS. The construction with finished modular cover or finished cover (single) and opening with Minimal profile keeps the front panels bound to the structures and aligned with the Open units.

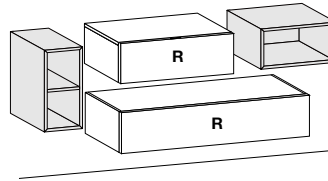
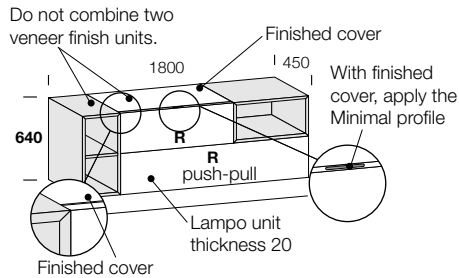

OPEN unit with continuous grain

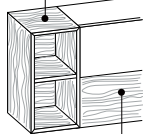

LAMPO front panel with horizontal grain

GRAIN DIRECTIONS

For all veneered and melamine finishes with grain, the grain runs continuously between the side panel and cover of Open units. Placing them next to or on top of veneered or melamine LamPO units with horizontal grain changes the direction of the grain and the colour tone.

OPENINGS



Drawer

Door

Drop-down

UPPER fronts: MINIMAL handle

LOWER fronts: PUSH-PULL

OPEN SIDEBOARDS WITH INTERMEDIATE OPEN UNITS

Sideboards finished with finished modular covers and front panels with exposed top edge use MINIMAL PROFILE OPENING, WHILE FRONT PANELS WITH TOP EDGE CONCEALED BY THE OPEN UNIT USE PUSH-PULL OPENING.

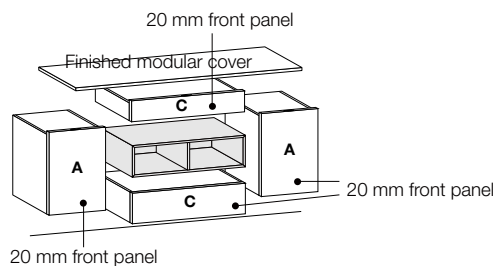
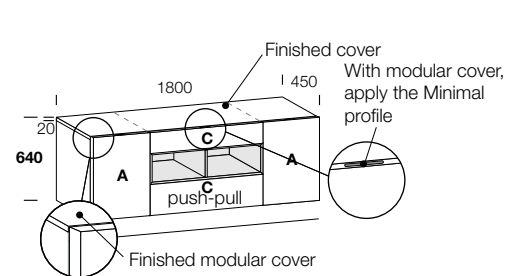

OPENINGS



Drawer

Door

Drop-down

UPPER fronts: MINIMAL handle

LOWER fronts: PUSH-PULL

TYPES

HANGING UNITS

Depth 450

BASE UNITS

Depth 450

TYPES	H 15	H 80	H 120	H 180
P-Floor-standing foot	P1			
M-Methacrylate Sospendo		M1	M2	
C-Cylindrical Sospendo			C2	C3
S-Shaped Sospendo		S1		

Depth 470

Internal/external lighting systems and power control options see page 2-13

HANGING UNITS

Depth 450

BASE UNITS

Depth 450

TYPES	H 15	H 80	H 120	H 180
P-Floor-standing foot	P1			
M-Methacrylate Sospendo		M1	M2	
C-Cylindrical Sospendo			C2	C3
S-Shaped Sospendo		S1		

Depth 470

Internal/external lighting systems and power control options see page 2-13

Storage units **Lampo Open**

Structural features

TYPES

OPEN SIDEBOARDS WITH 4-SIDED FRAME

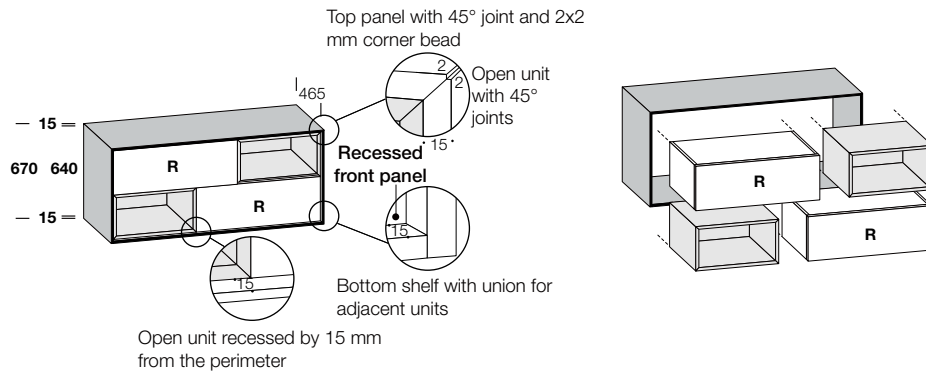

OPENINGS
Push-pull



BASE UNITS

Depth 465/561

Types	H 15	H 80	H 120	H 150	H 180
P -Floor-standing foot	P1				
M -Methacrylate Sospendo		M1	M2		
C -Cylindrical Sospendo			C2	C3	
S -Shaped Sospendo		S1			
V -Domino Sospendo				V2	

Depth 485

Internal/external lighting systems and power control options see page 2-13

METHACRYLATE SPACER

Th. 12 for self-supporting compositions
D. 546 and 450

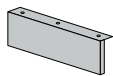

D Code

403 CYDM400

H 175 floor-standing
H 255 floor-standing
H 335 floor-standing

53 56 76

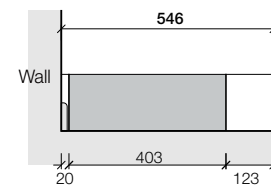
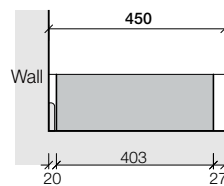

Floor-standing spacers should be placed at a maximum distance of 150mm from the sides of the units above and their distance from the point at which they encounter the unit below should be no more than 900mm.

