

Insieme

STRUCTURAL FEATURES

PRODUCT DATA SHEET

STRUCTURE thickness 20 mm, TOP thickness 15 mm and FRONTS thickness 20 and 35 mm in *wood particle board panels coated with synthetic melamine also matt, glossy lacquered or metal or with painted wood veneer. With "gloss front panel" we refer to the external side and its gloss edges, while the interior is supplied with the corresponding matt lacquered colour.

BACK PANELS in medium density *wood particle board panels thickness 4 mm with synthetic melamine.

TURN DRAWER thickness 12 mm and BOTTOM thickness 8 mm in *wood particle board panels with melamine Sketch Roccia.

Opening through a side groove in the same colour as the structure when lacquered or with the proposed combinations in all other cases.

Black ABS FEET, diam. 50 mm, height 27 mm, 12 mm adjustable from the inside.

*Wood and derivatives components according to the following standards: E1-TSCA-CARB-UBA.

RUNNERS FOR DRAWERS

Opening with side grip: High sliding full extraction metal runners with FULL EXTRACTION, end-of-run buffer with dynamic capacity of 30 kg. "Blumotion" soft-closing mechanism integrated in the runner for a silence and soft closing system. Anti-tilting pin, vertical and inclination adjustment of fronts incorporated in all system runners. Additional stabilizer bar for drawers width 750 and 900 and "MOVENTO" runners with built-in stabilizer and also front side adjustment for drawers width 1200 and 1500.

DRAWER UNITS ARE DELIVERED WITH A NON-TILTING DEPTH ADJUSTMENT BRACKET TO BE FIXED TO THE WALL.

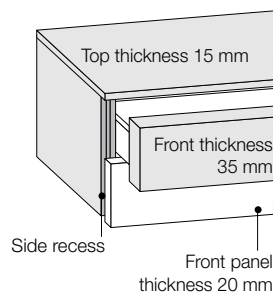
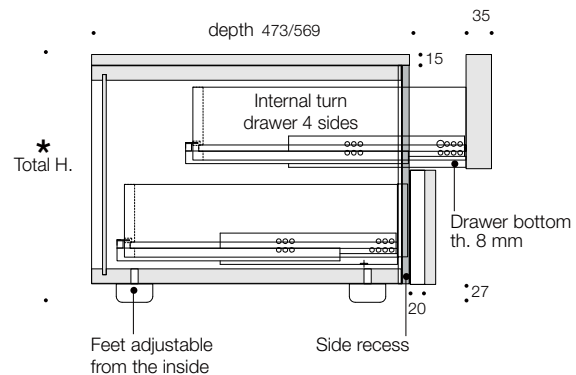

Insieme

Structural types

BEDSIDE TABLES

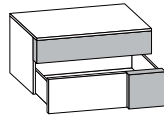
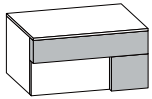

Front with double thickness
35/20 joined to an internal turn
drawer

DRAWER CHESTS

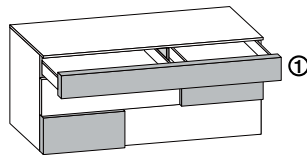
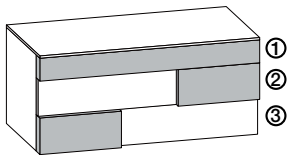

35 mm front panel
With double turn drawer

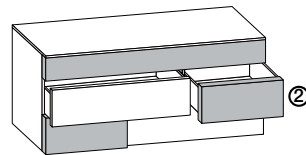

35 mm 1 front panel
20 mm 1 front panel
With 2 splitted turn drawers

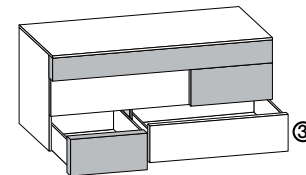

35 mm 1 front panel
20 mm 1 front panel
With 2 splitted turn drawers

UNIT WITH 6 DRAWERS

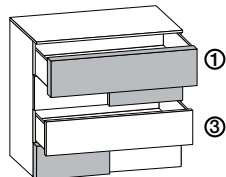
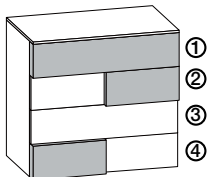

① 35 mm front panel
③ 20 mm front panel
With internal turn drawer

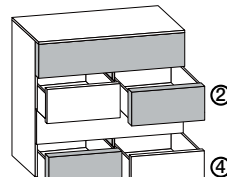

② 35/20 mm front panel
④ 35/20 mm front panel
With 2 splitted turn drawers

MATCHING THE SIDE RECESS GRIP WITH THE STRUCTURE

CARCASS:

Carbone OAK
Argilla OAK
Grigio OAK
Avana OAK
Cuba OAK
ROVERE NODATO Naturale
ROVERE NODATO Caramello
CANALETTO WALNUT

Matt LACQUERED
Glossy LACQUERED
Metal LACQUERED

MELAMINE Olmo Medio
MELAMINE Olmo Scuro
MELAMINE Loto Natura
MELAMINE Loto Tortora
MELAMINE Loto Terra
MELAMINE Sketch Sabbia
MELAMINE Sketch Poccia
MELAMINE Sketch Tabacco
MELAMINE Econoce

SIDE RECESS:

BROWN
Matt TERRANOVA
BROWN
Matt DUNE
BROWN
BROWN
BROWN
BROWN

Matt LACQUERED
Glossy LACQUERED
Metal LACQUERED

Matt SILICE
BROWN
Matt GRIGIO CORDA
Matt GRIGIO CORDA
Matt TERRANOVA
Matt SAND
Matt SILICE
Matt CASTORO
BROWN