

# Drawer units **Cabaret**

## STRUCTURAL FEATURES

### PRODUCT DATA SHEET

STRUCTURE, FRONTS and COVERS in wood particle board panels \* thickness 20 mm coated with synthetic melamine also matt, glossy lacquered or metal or with painted wood veneer. With "gloss front panel" we refer to the external side and its gloss edges, while the interior is supplied with the corresponding matt lacquered colour.

BACK PANELS in medium density wood particle board panels\* thickness 8 mm with synthetic melamine.

TURN DRAWER thickness 12 mm and BOTTOM thickness 8 mm in \*wood particle board panels with melamine Sketch Roccia.

External transparent glass shelf thickness 12 mm.

PERIMETER made of medium density wood particle board panels\* thickness 10 mm coated with synthetic melamine matt lacquered and metal or with painted wood veneer.

Black ABS FEET, diam. 50 mm, height 27 mm, 12 mm adjustable form the inside.

SOSPENDO BASE SUPPORT consisting of black metal frame with shaped laser-cut steel feet finished with epoxy or liquid painting.

Ceramic TOP made of 12mm thick x 1620x3240mm slabs cut at random in terms of dimensions and pattern direction. Scratchproof and highly abrasion resistant, these tops are eco-compatible and do not release dissolved elements.

\*Components in wood and derivates according to the following standards: E1-TSCA-CARB-UBA.

**Cabaret drawer units are made with standard Lampo units with finished cover and for modular cover or, with ceramic top, Lampo units with lowered top. Fronts with visible top edging have Minimal handles, whereas the others come with a push-pull mechanism. Cabaret veneered and lacquered perimeters with thickness 10 mm have a finished full back panel. They can be positioned on floor with feet and also mounted on base supports with different types of supports, or hanged.**

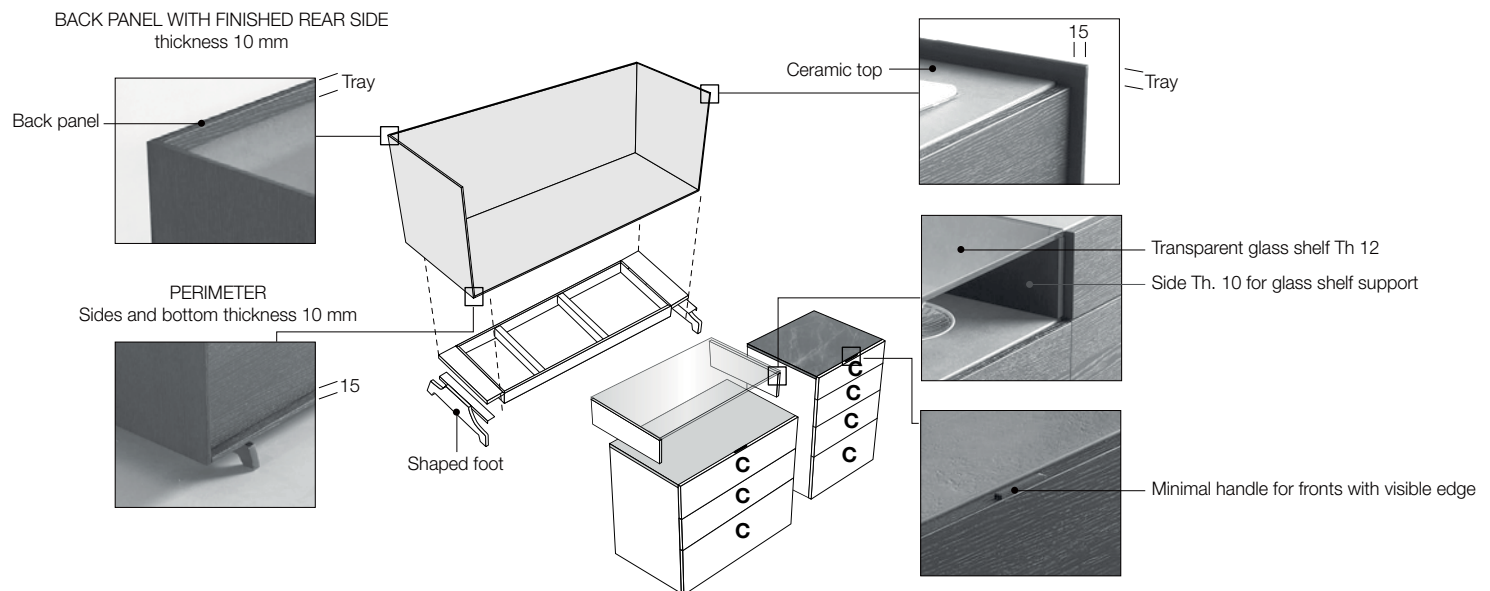

### DRAWER OPENING

**Fronts with visible top edging have Minimal handles, whereas the others come with a push-pull mechanism.**

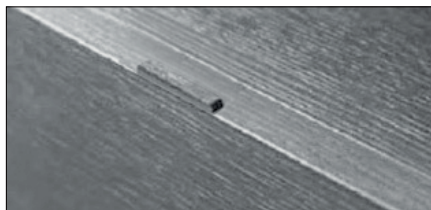

#### MINIMAL PROFILE

it is included in the price of the unit and positioned at the centre of the front panel, flush with the external edge.

Opening of upper drawer

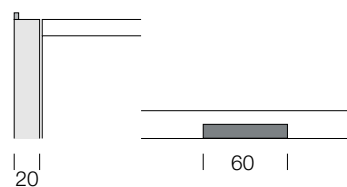

### FINISHES IN COMBINATION

WOODEN DRAWER FINISHES:	MINIMAL PROFILE FINISH:
Carbone OAK	BROWN
Argilla OAK	Matt CRETA
Grigio OAK	Matt ANTRACITE
Avana OAK	Matt DUNE
Cuba OAK	BROWN
ROVERE NODATO Naturale	Matt MAGNOLIA
ROVERE NODATO Caramello	Matt MAGNOLIA
TERMOTRATTATO OAK	BROWN
CANALETTO WALNUT	BROWN
Matt/glossy LACQUERED	Matt/glossy LACQUERED
Metal LACQUERED	Metal LACQUERED
MELAMINE Loto Natura	Matt GRIGIO CORDA
MELAMINE Loto Tortora	Matt GRIGIO CORDA
MELAMINE Loto Terra	Matt TERRANOVA
MELAMINE Sketch Sabbia	Matt SAND
MELAMINE Sketch Roccia	Matt SILICE
MELAMINE Sketch Tabacco	Matt CASTORO
MELAMINE Econoce	BROWN

# Drawer units **Cabaret**

Structures

## DRAWER UNITS

### LINEAR STORAGE UNITS

#### CABARET ONE

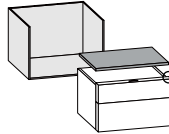

#### FINISHED OR MODULAR COVER TH20

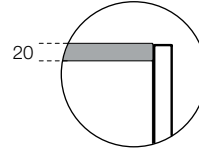

#### MODULAR CERAMIC COVER TH 12

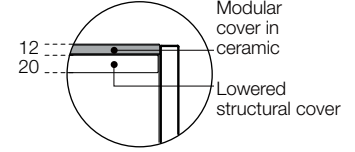

Modular cover in ceramic  
Lowered structural cover

#### CABARET LINE

### LINEAR STORAGE UNITS

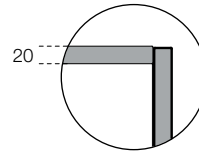
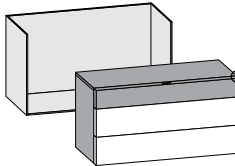
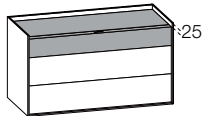

Cover in the same finish as the first drawer

#### CABARET GLASS

### STORAGE UNITS WITH GLASS COMPARTMENT

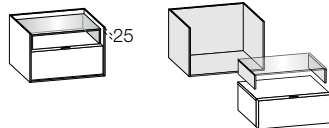

### STORAGE UNITS WITH SIDE GLASS COMPARTMENT

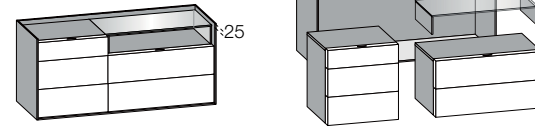

#### CABARET STEP

### STORAGE UNITS WITH STEP H 185

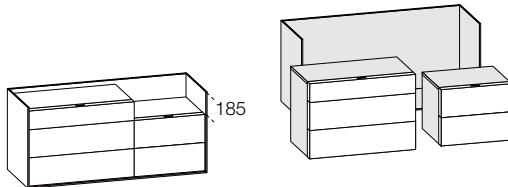

### STORAGE UNITS WITH STEP H 105

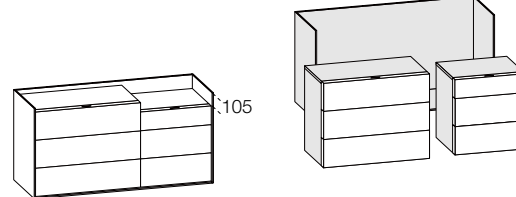

## TYPES OF STRUCTURES

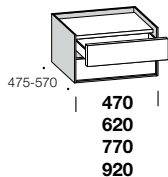

Drawer units W 450 - 600 - 750 - 900  
Drawer with one turn drawer

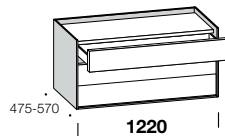

Drawer units W 1200  
With turn drawer with anti-warping metal bars and mechanism for opening stabilisation. Cover max capacity 10 kg

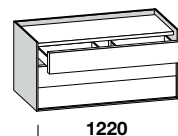

Drawer units W 1200  
With double turn drawer and internal partition (upon request) to support heavier weights

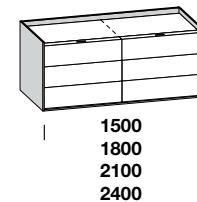

Combination drawer units W 1500-1800-2100-2400  
Obtained by combining elements with the same height or different height with carcasses divided with one finishing cover.

## RUNNERS FOR DRAWERS

**Opening with minimal profile:** High sliding full extraction metal runners with FULL EXTRACTION, end-of-run buffer with dynamic capacity of 30 kg. "Blumotion" soft-closing mechanism integrated in the runner for a silence and soft closing system. Anti-tilting pin, vertical and inclination adjustment of fronts incorporated in all system runners. Additional stabilizer bar for drawers width 900 and "MOVENTO" runners with built-in stabilizer and also front side adjustment for drawers width 1200 and 1500.

**Push-pull opening:** High sliding full extraction metal runners with FULL EXTRACTION, end-of-run buffer with dynamic capacity of 30 kg. Integrated sliding synchronizer in drawer runners wider than 450. Anti-tilting pin, vertical and inclination adjustment of fronts incorporated in all system runners. Drawers width 1200 and 1500 with "MOVENTO" runners and side adjustment of fronts.

**DRAWER UNITS ARE PROVIDED UPON REQUEST WITH AN ADJUSTABLE DEPTH, NON-TILTING BRACKET TO ATTACH TO THE WALL.**

# External lighting for **Cabaret** base units

## Drawer units Cabaret floor-standing or on base support D 495/590

BACK PANEL FOR FLOOR-STANDING CABARET DRAWER UNIT WITH FOOT OR SOSPENDO BASE SUPPORT  
**The back panel is fixed to the back of the Cabaret perimeter by spacing the drawer units 19 mm from the wall.**

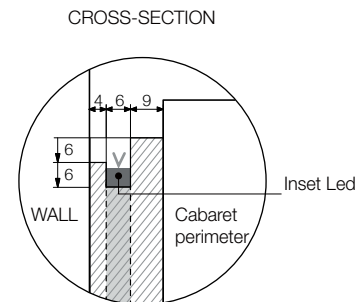
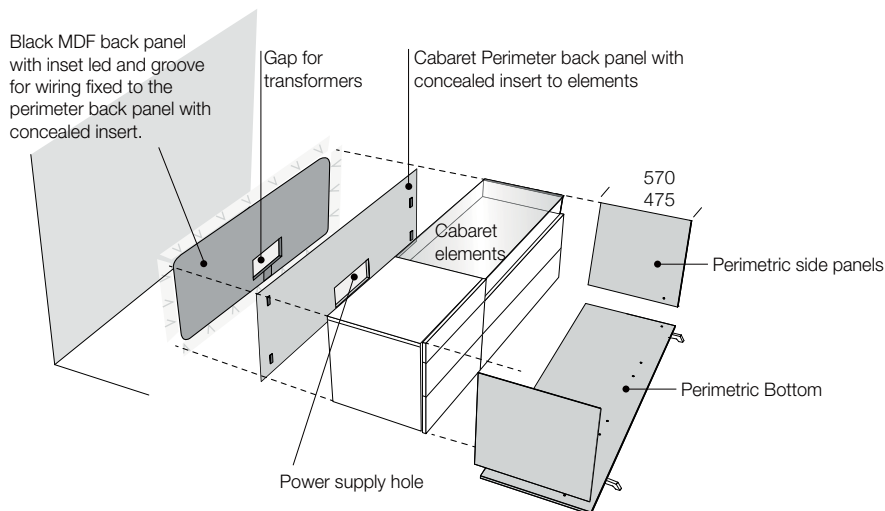



### Back panel with led

Customized heights not available. Width can be adjusted by 25mm at the price of the next size up.

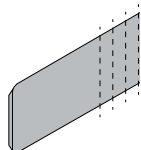
If perimeters develop over more than 6m two LED systems are coupled.



	W	H	Code	Back panel WITH LED 3000K on top and sides 	Max development in W	Back panel WITH LED 3000K 4 sides 	Max development in W
<b>470</b>		From 355 to 515	CHBN0505		14.04		18.42
		From 675 to 755	CHBN0507		18.84		23.22
		1155	CHBN0511		26.84		31.22
<b>620</b>		From 355 to 515	CHBN0605		15.54		21.42
		From 675 to 755	CHBN0607		20.34		26.22
		1155	CHBN0611		28.34		34.22
<b>770</b>		From 355 to 515	CHBN0805		17.04		24.42
		From 675 to 755	CHBN0807		21.84		29.22
		1155	CHBN0811		29.84		37.22
<b>920</b>		From 355 to 515	CHBN0905		18.54		27.42
		From 675 to 755	CHBN0907		23.34		32.22
		1155	CHBN0911		31.34		40.22
<b>1220</b>		From 355 to 515	CHBN1205		21.54		33.42
		From 675 to 755	CHBN1207		26.34		38.22
<b>1520</b>		From 355 to 515	CHBN1505		24.54		39.42
		From 675 to 755	CHBN1507		29.34		44.22
<b>1820</b>		From 355 to 515	CHBN1805		27.54		45.42
		From 675 to 755	CHBN1807		32.34		50.22
<b>2120</b>		From 355 to 515	CHBN2105		30.54		51.42

Power supply max 75W already included in the price of back panel with led (with protection against overloading)

For installations and power control options see page 71

Remote control NHT012

# Features and external lighting **Cabaret** wall unit

## Drawer units Cabaret wall units D 495

### BLACK MDF BACK PANEL FOR CABARET WALL UNIT

Cabaret drawer units cannot be mounted directly on the wall. Use a black 19mm thick MDF back panel prepped and provided with hardware for hanging the storage units. The panel can be completed with LED perimeter lighting inset into the panel thickness.

**The hanging back panel keeps units at a distance of 19mm from the wall.**

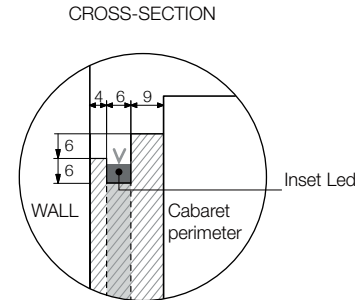
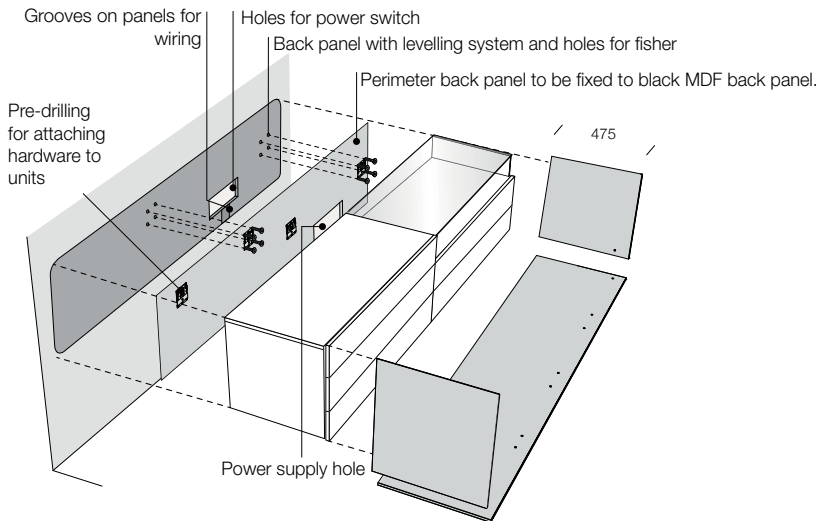

Wall plugs for attaching back panels to walls should be suitable for the material to which they will be secured.

**ATTENTION:** the capacity of 120 kg is related to the hardware mounted in each furniture. The given plugs for the wall mounting may not be suitable in certain situations. The responsibility concerning the assembly of the furniture belongs to the buyer, who must evaluate the resistance of his/her wall. The stability and capacity of wall-mounted elements are guaranteed by the proper assembly and by following our instructions correctly.

### SURCHARGE FOR LED LIGHT ON BLACK MDF BACK PANEL

Customized heights not available.

If perimeters develop over more than 6m two LED systems are coupled.

	W	H	Code	Surcharge LED 3000K on top and sides	Max development in W	Surcharge LED 3000K 4 sides	Max development in W
	<b>470</b>	From 320 to 515			14.04		18.42
	<b>620</b>	From 320 to 515			15.54		21.42
	<b>770</b>	From 320 to 515			17.04		24.42
	<b>920</b>	From 320 to 515			18.54		27.42
	<b>1220</b>	From 320 to 515			21.54		33.42
	<b>1520</b>	From 320 to 515			24.54		39.42
	<b>1820</b>	From 320 to 515			27.54		45.42
	<b>2120</b>	From 320 to 515			30.54		51.42

Power supply max 75W already included in the surcharge for led (with protection against overloading)

For installations and power control options see page 71

Remote control NHT012